

500 SERIES NAIL ON HORIZONTAL SLIDER
 501 REPLACEMENT/EQUAL LEG HORIZONTAL SLIDER

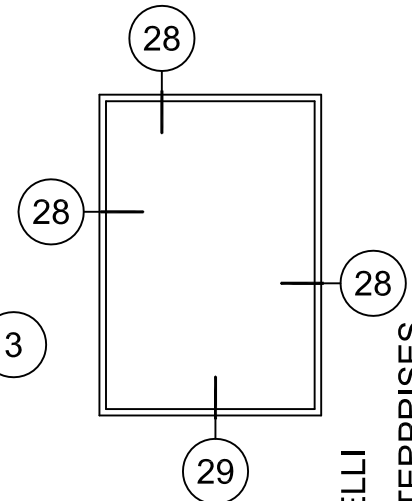

500R SERIES NAIL ON RECESSED WINDOW

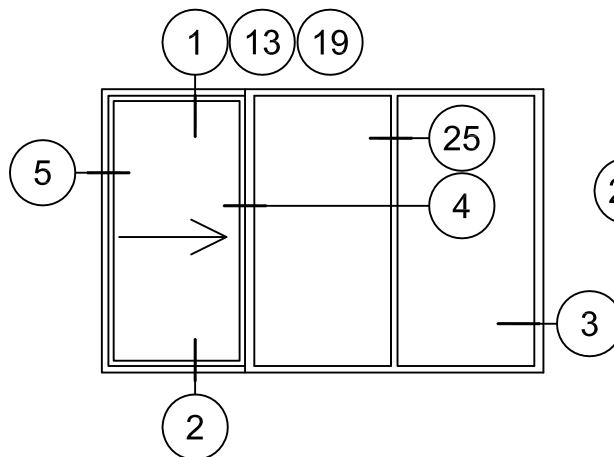
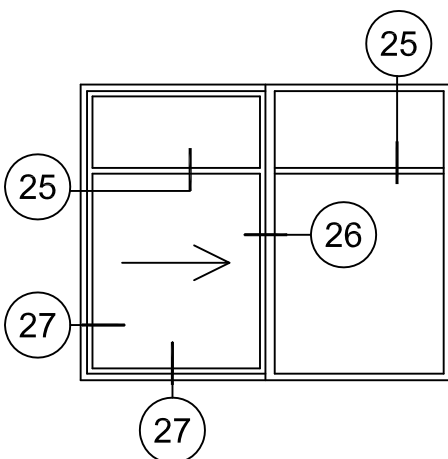
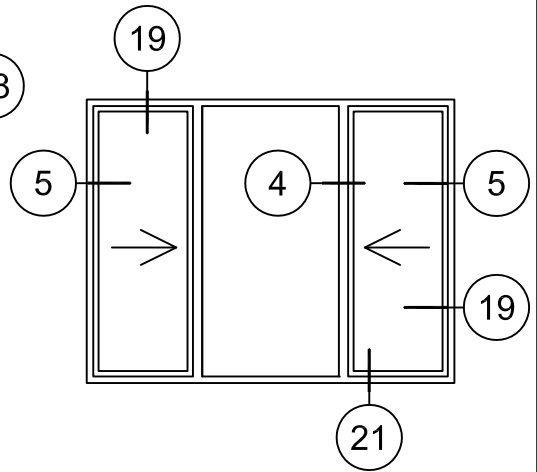
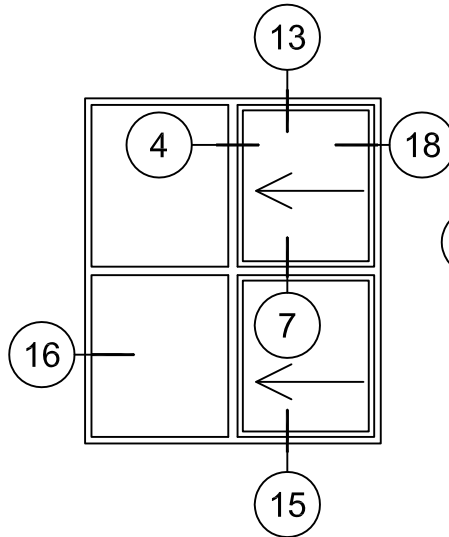
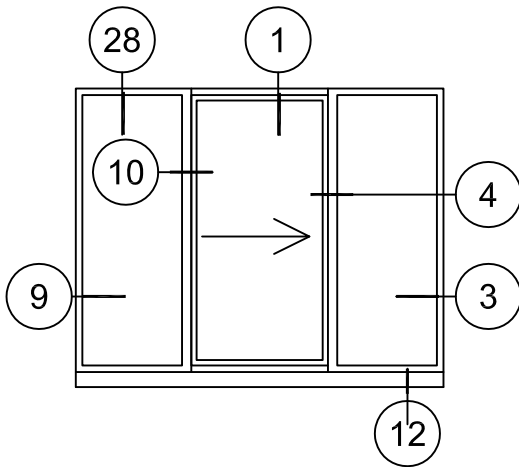
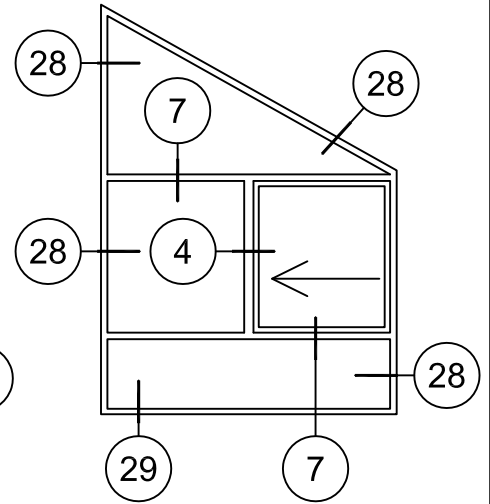
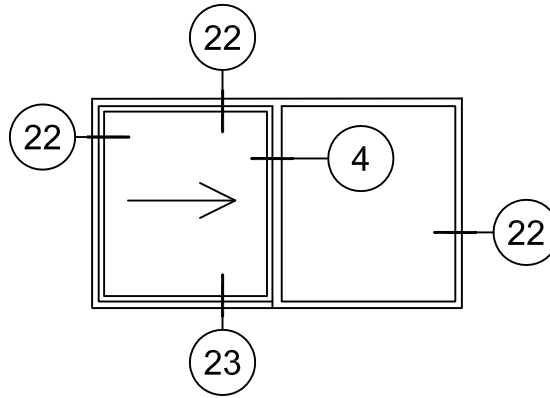
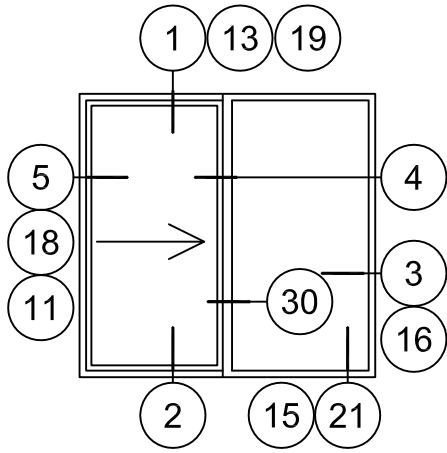
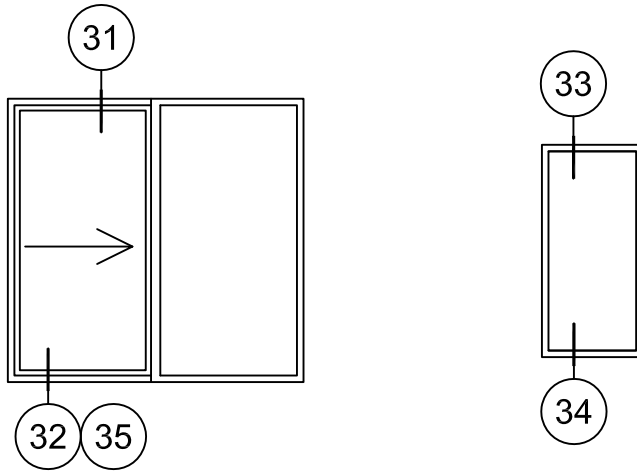

WINDOW DIMENSION

1 HEAD

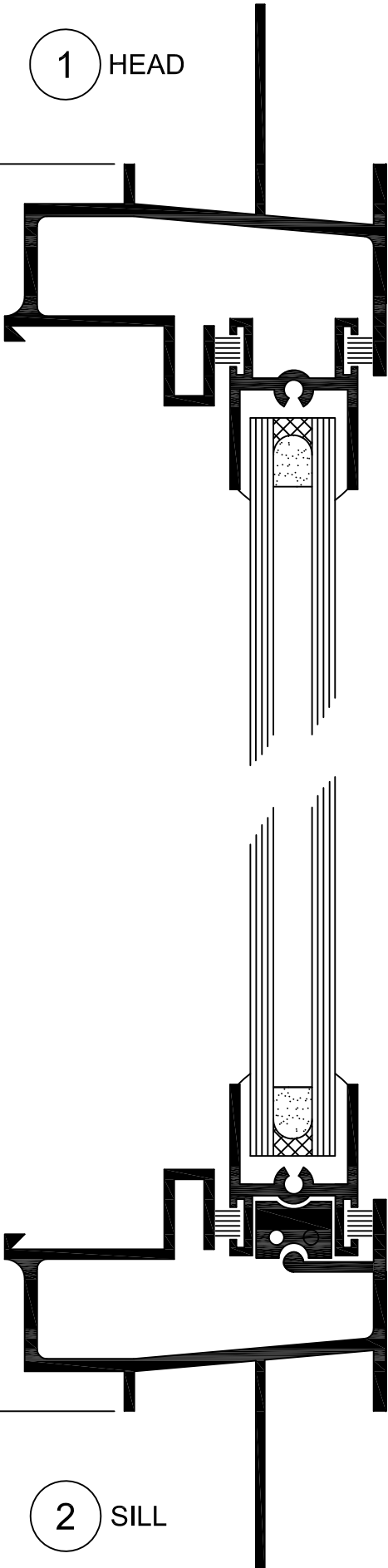

2 SILL

3 FIXED JAMB

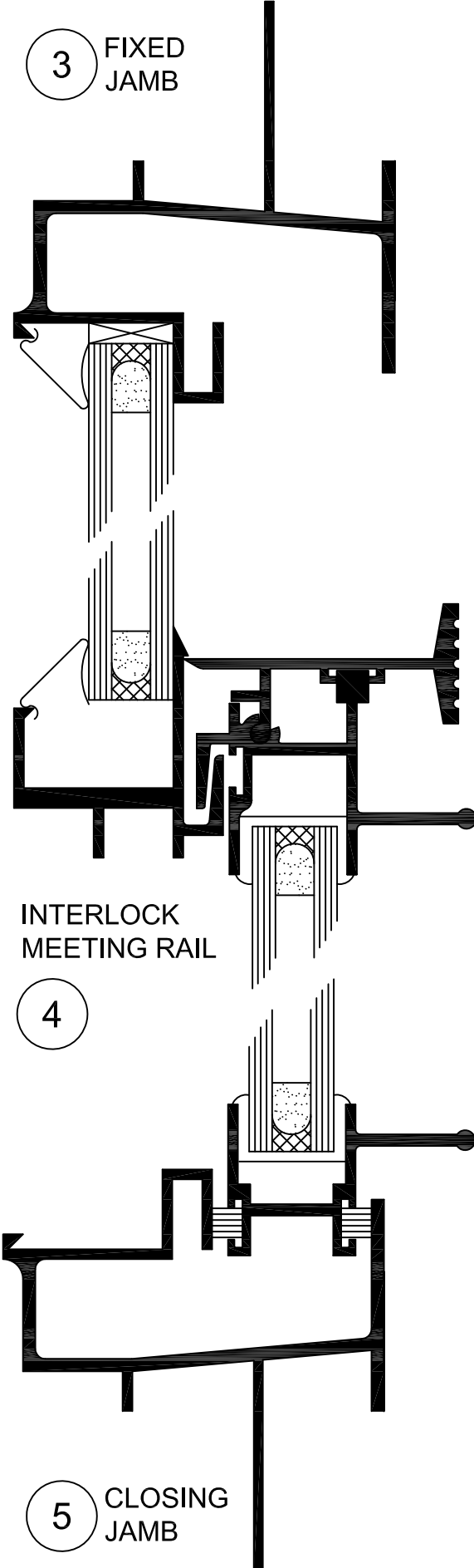

INTERLOCK MEETING RAIL

4

5 CLOSING JAMB

500 SERIES NAIL ON SLIDER

BONELLI ENTERPRISES

1 HEAD

9 FIXED JAMB

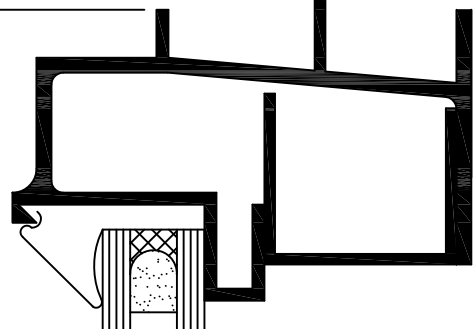
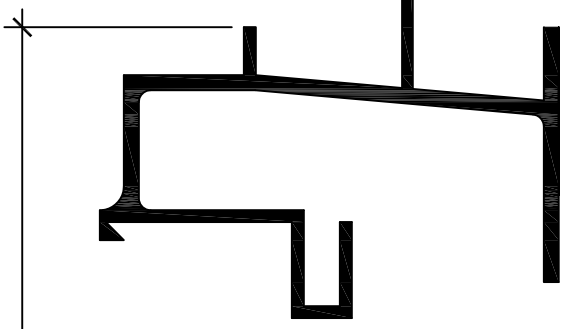

WINDOW DIMENSION

WINDOW DIMENSION

7 HORIZONTAL TRANSOM

10 HORIZONTAL OR VERTICAL TRANSOM

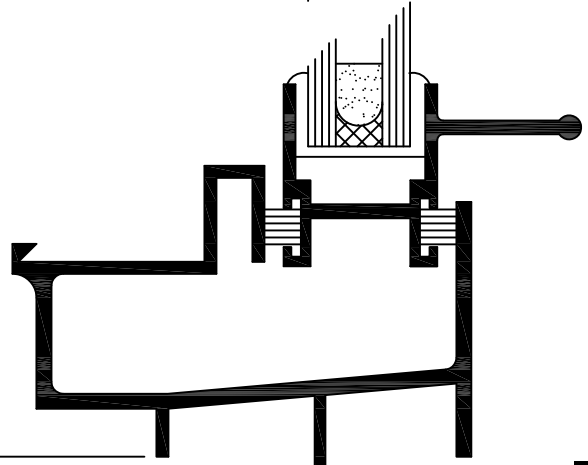
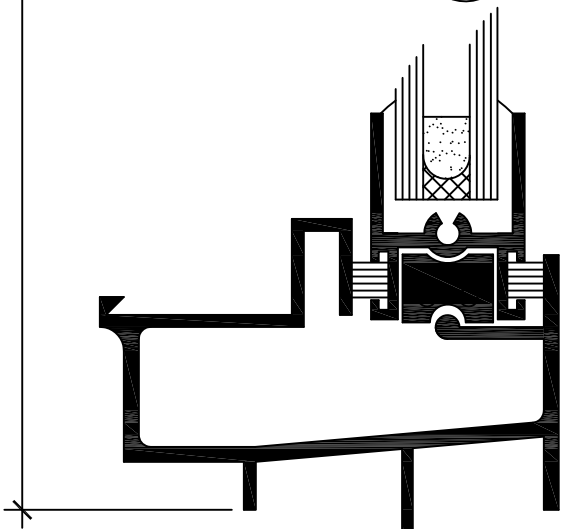

2 SILL

11 JAMB

500 SERIES NAIL ON SLIDER AND TRANSOM

BONELLI ENTERPRISES

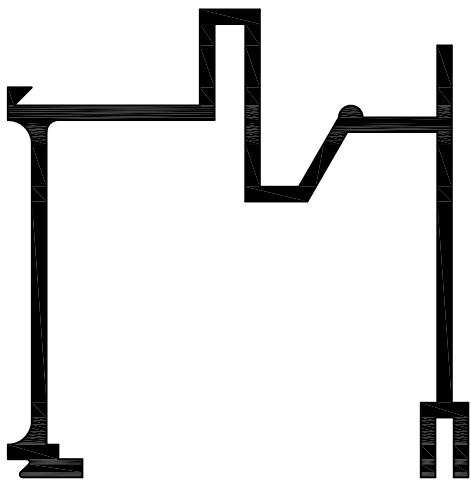

HIGH WATER SILL FOR
C 40 RATING

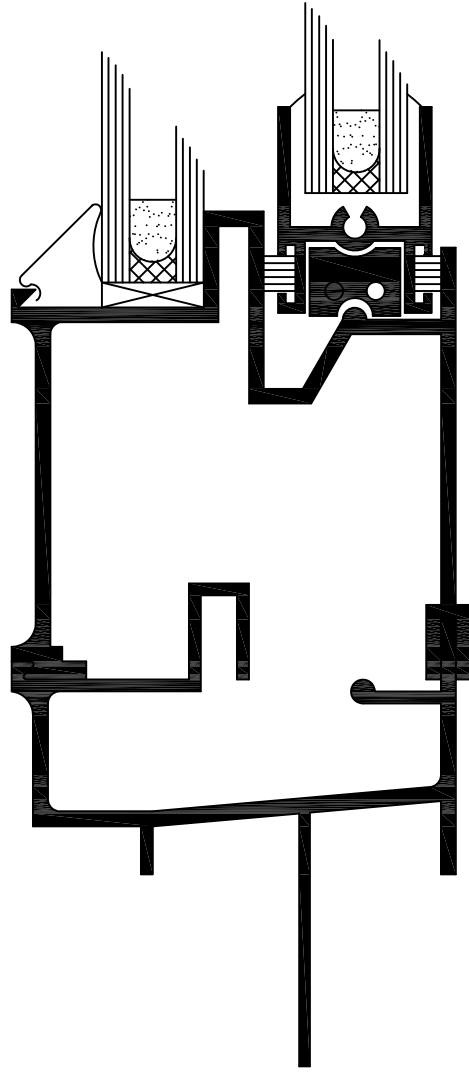

12 NAIL ON SILL
W/HIGH WATER

500 HIGH WATER SILL

WINDOW DIMENSION
NET O.D. (OUTSIDE DIMENSION)

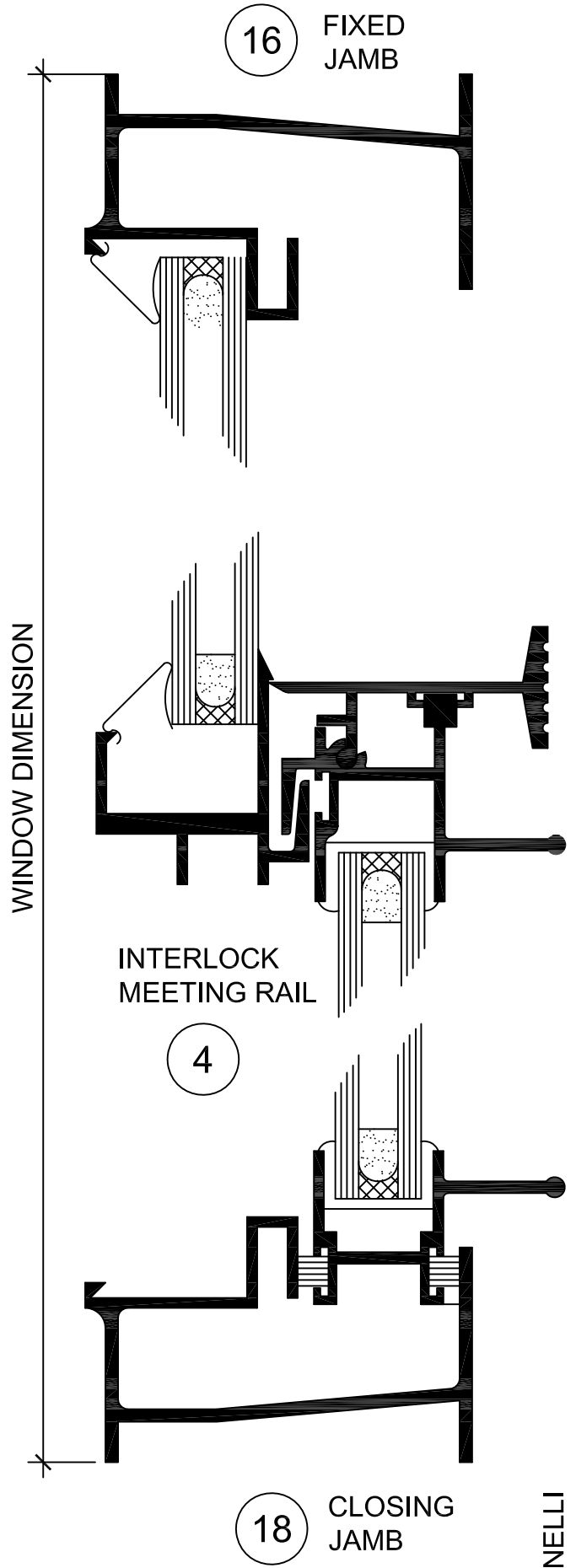
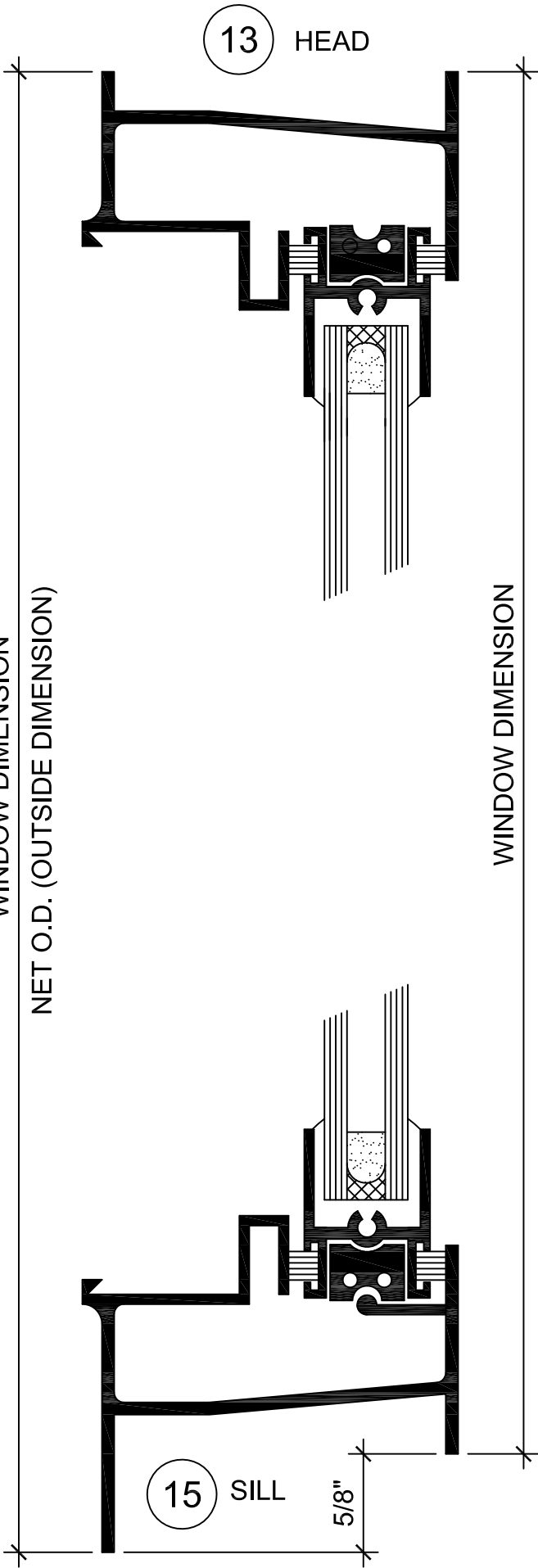

501 SERIES REPLACEMENT SLIDER AND TRANSOM

BONELLI
ENTERPRISES

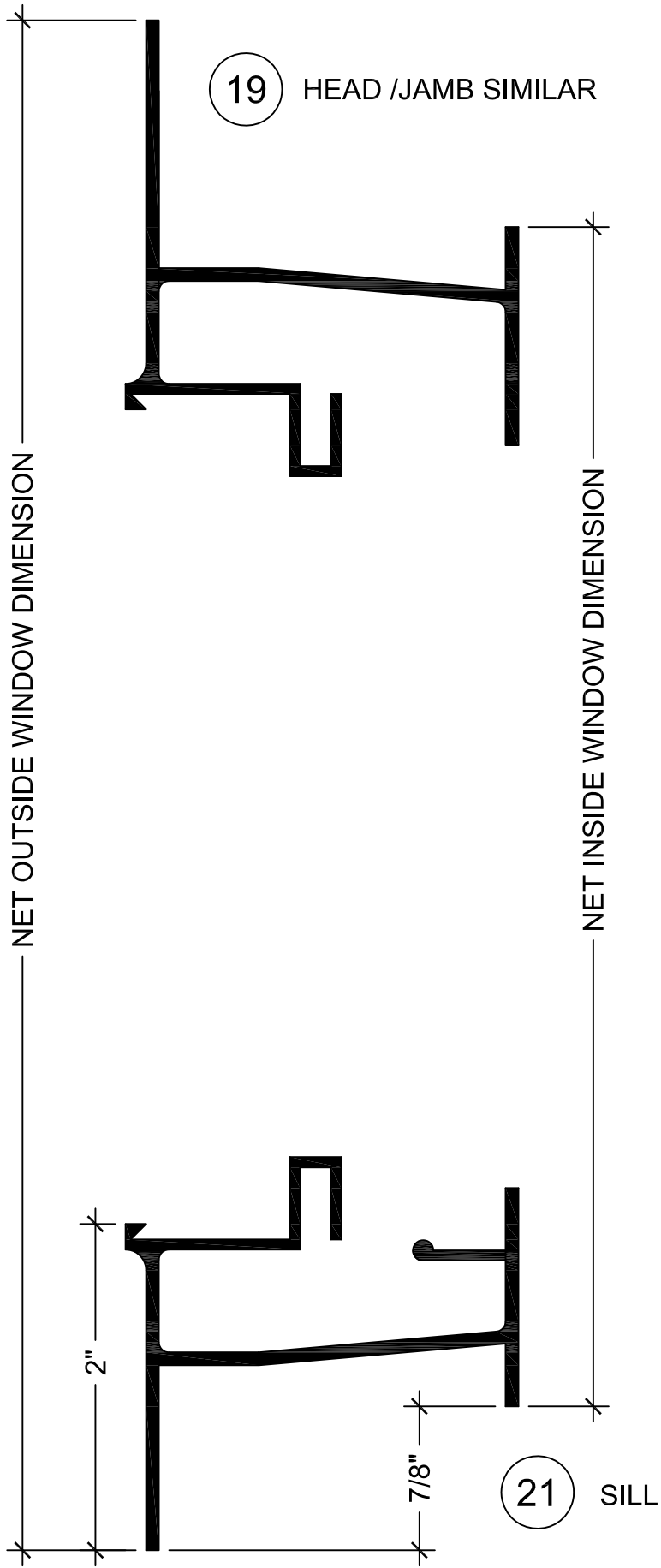

501 SERIES REPLACEMENT SLIDER

BONELLI
ENTERPRISES

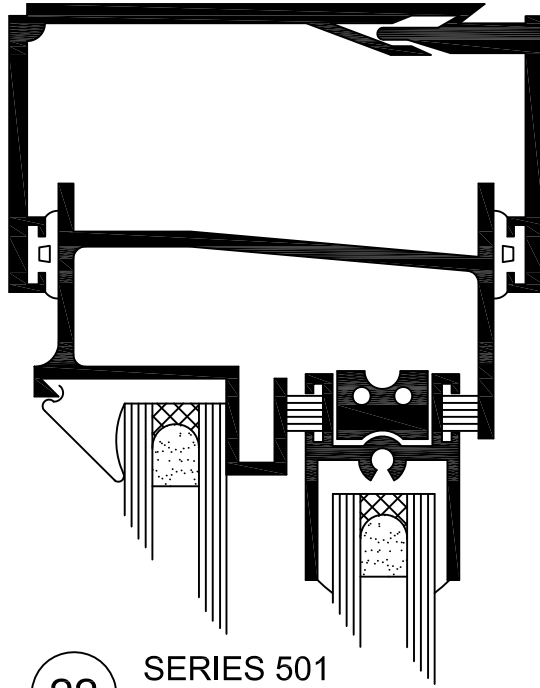

22 SERIES 501
COMPENSATION CHANNEL
HEAD/JAMB SIMILAR

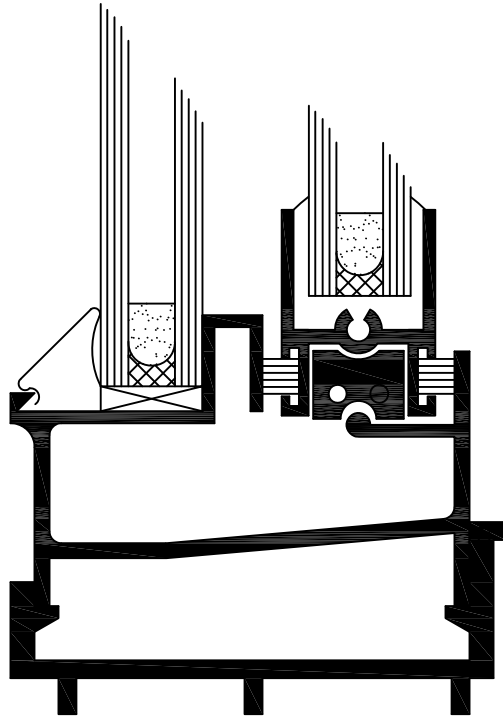

23 SERIES 501
COMPENSATION CHANNEL
SILL TRACK

501 SLIDER WITH COMPENSATION CHANNEL

MATCH LINE A

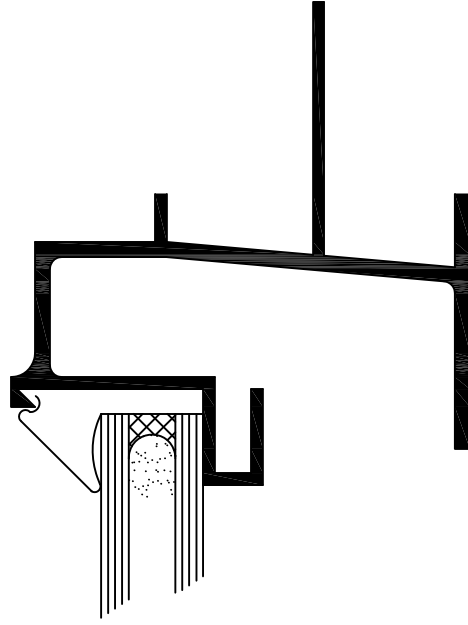

1 HEAD
JAMB SIMILAR

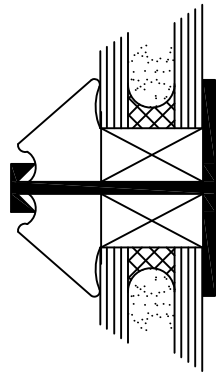

25 T BAR
(1-1/16" FACE)

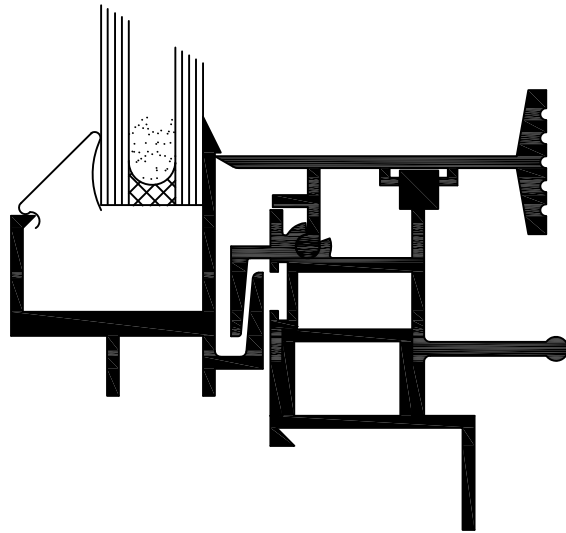

26 INTERLOCK

500 SERIES TRUE DIVIDED LITE SLIDER

MATCH LINE B

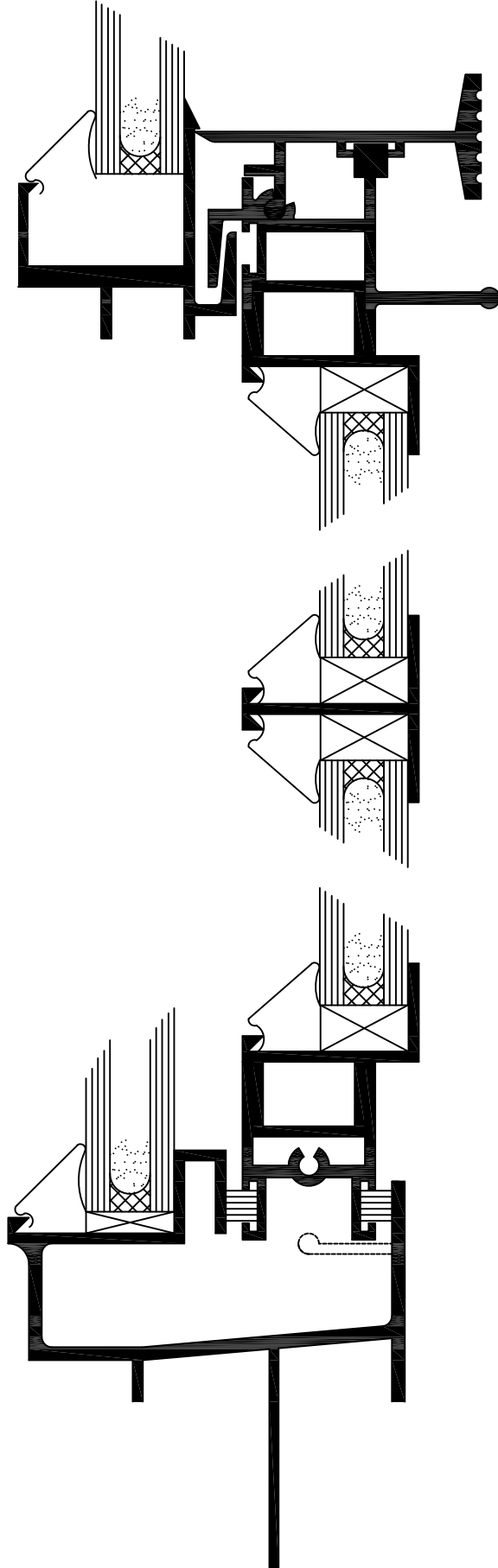

26 INTERLOCK FOR T.D.L.

25 T BAR FOR T.D.L. (1/16" FACE)

27 SILL FOR T.D.L. JAMB SIMILAR

500 SERIES TRUE DIVIDED SLIDER

BONELLI ENTERPRISES

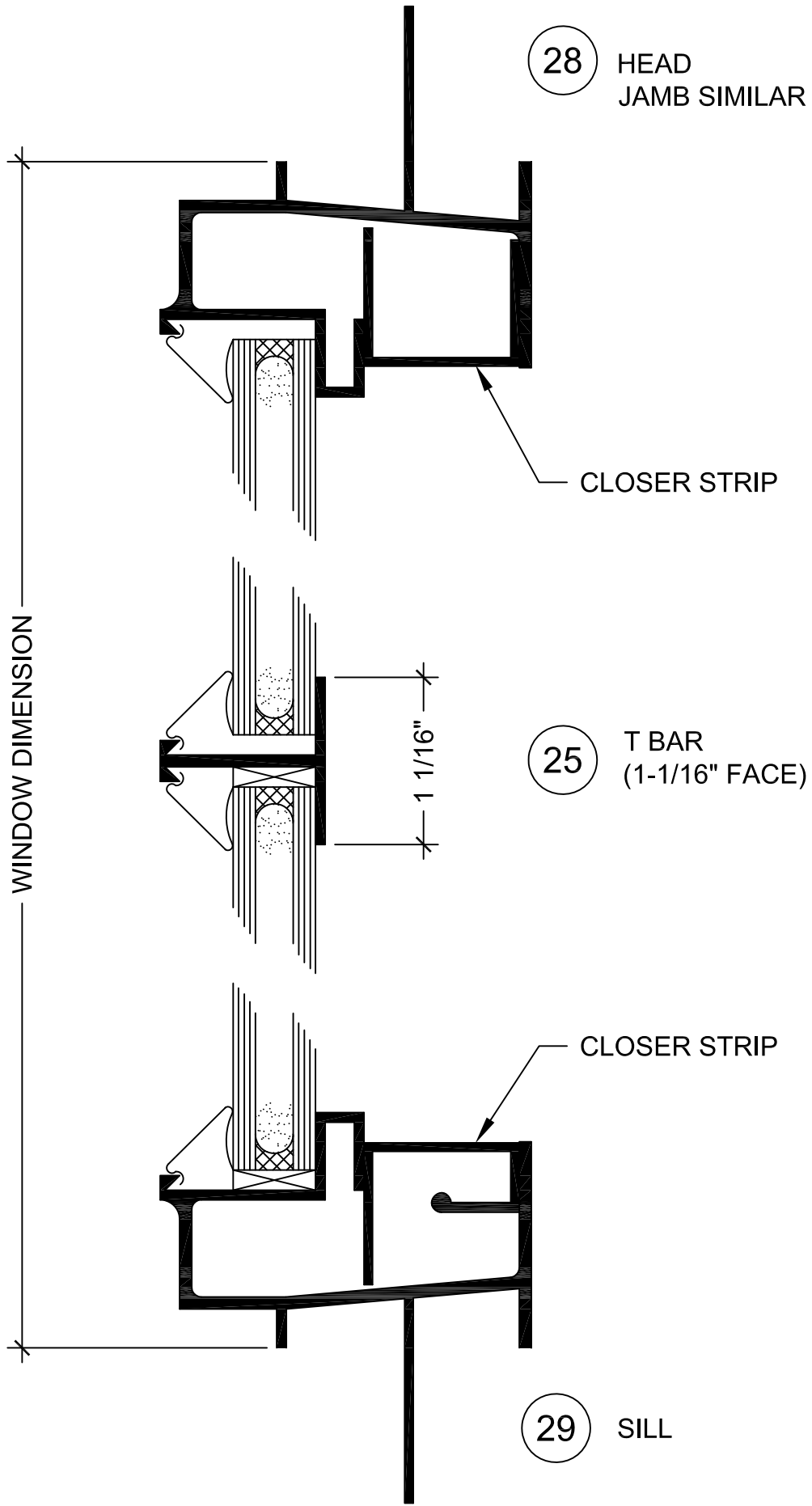

500 SERIES TRUE DIVIDED FIXED SLIDER

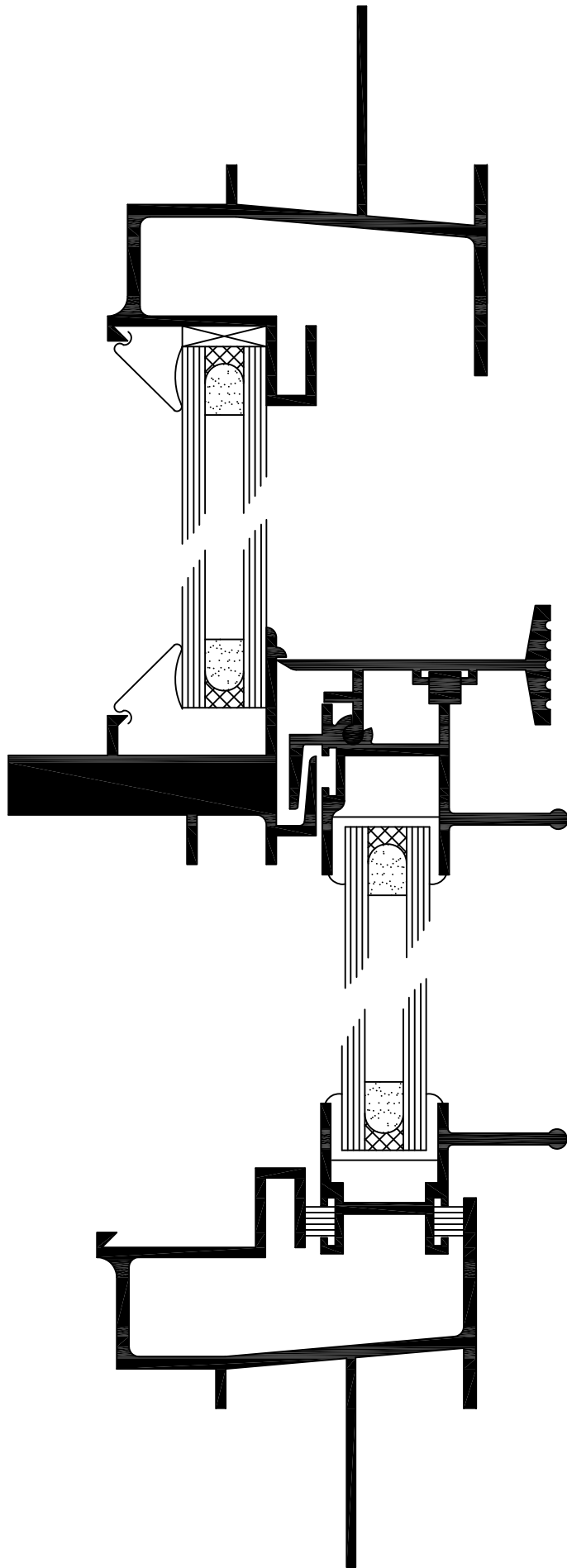

3 FIXED JAMB

30 HEAVY DUTY MEETING RAIL

5 CLOSING JAMB

500 SERIES SLIDER WITH HEAVY DUTY MEETING RAIL

BONELLI
ENTERPRISES

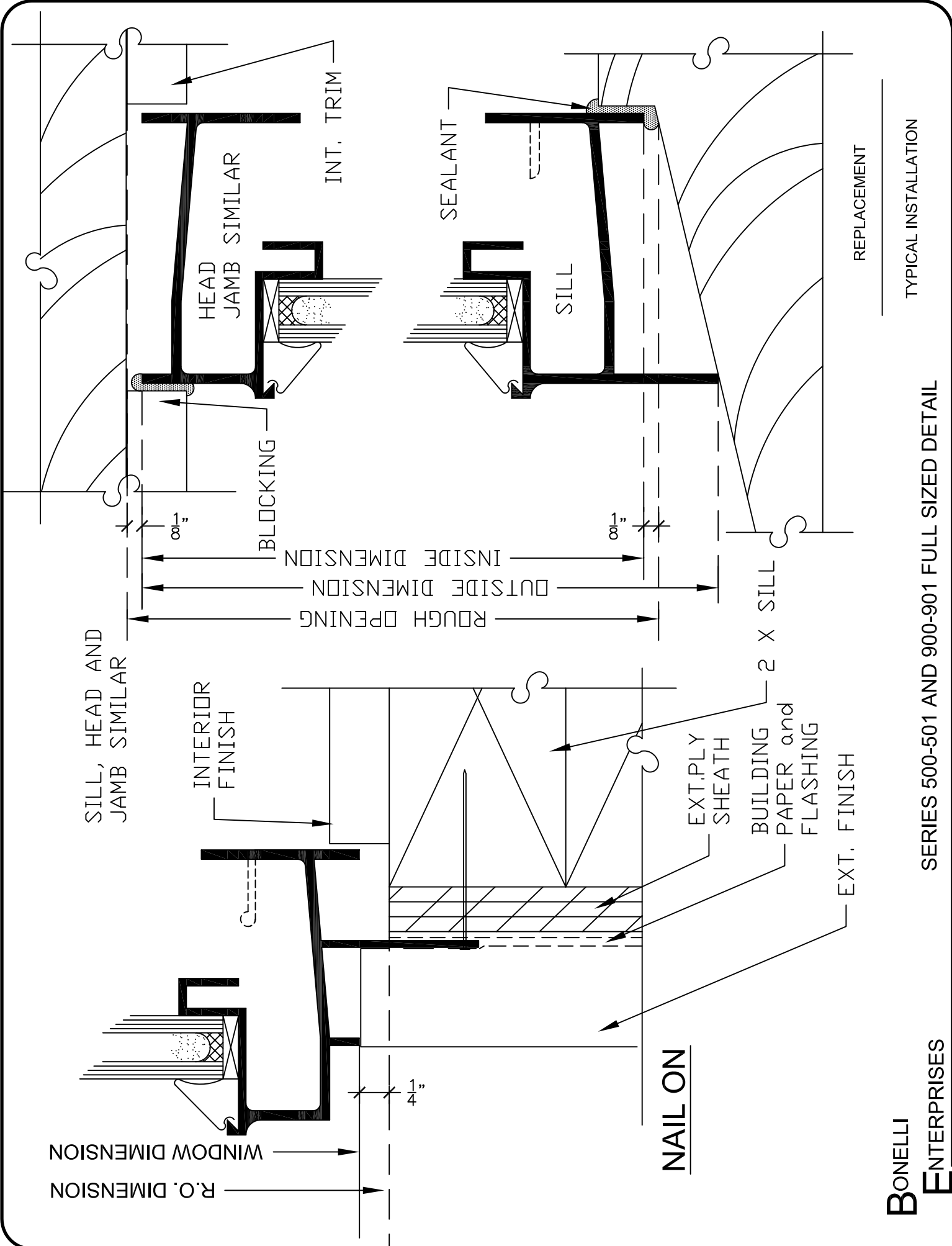

REPLACEMENT
TYPICAL INSTALLATION

SERIES 500-501 AND 900-901 FULL SIZED DETAIL

WINDOW AND R.O. DIMENSION

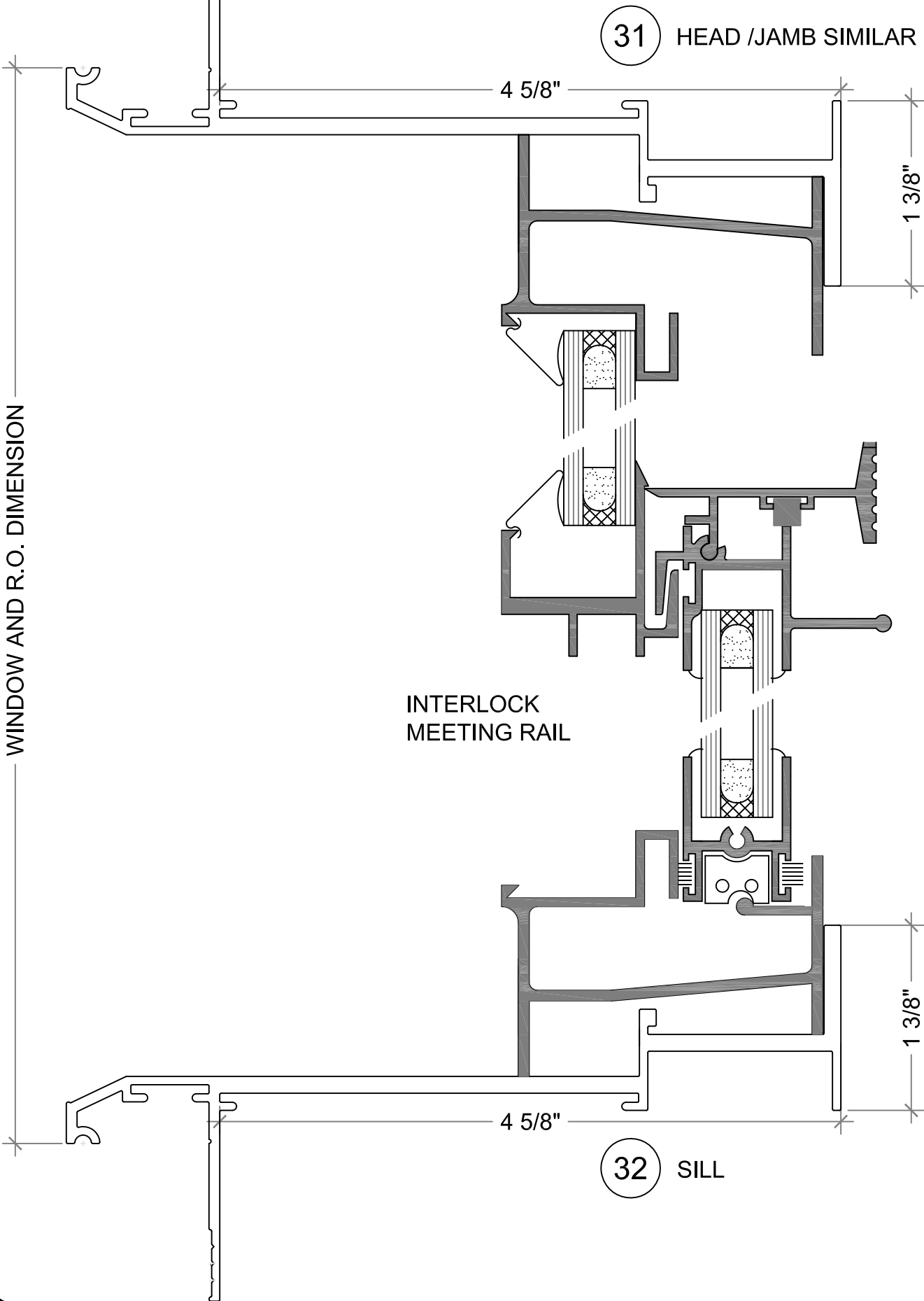

BONELLI 500R SERIES RECESSED SLIDERS AND SINGLE HUNG RECESSED NAIL ON WINDOW
ENTERPRISES

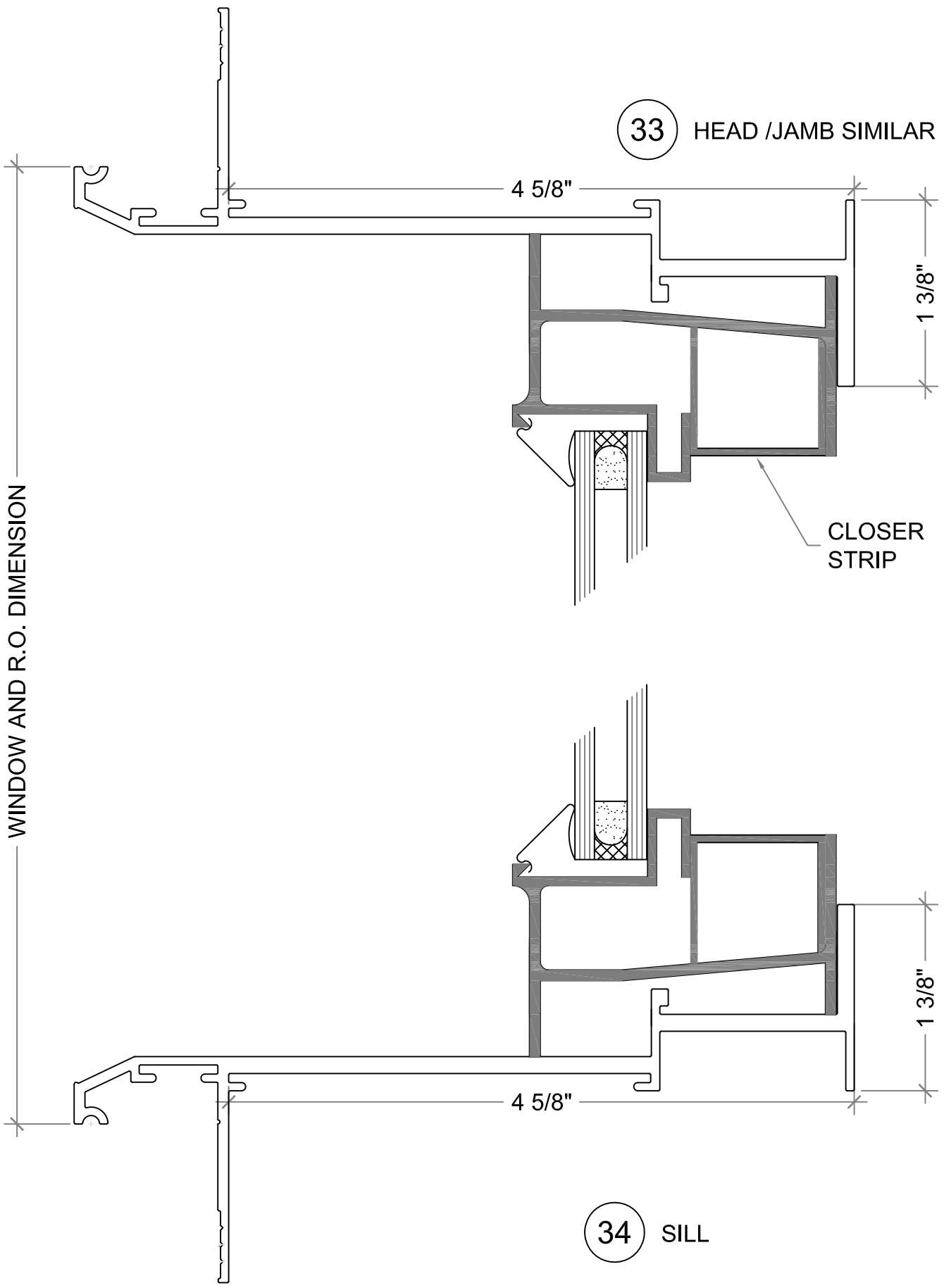

500R SERIES RECESSED SLIDERS AND SINGLE HUNG RECESSED NAIL ON WINDOW

WINDOW AND R.O. DIMENSION

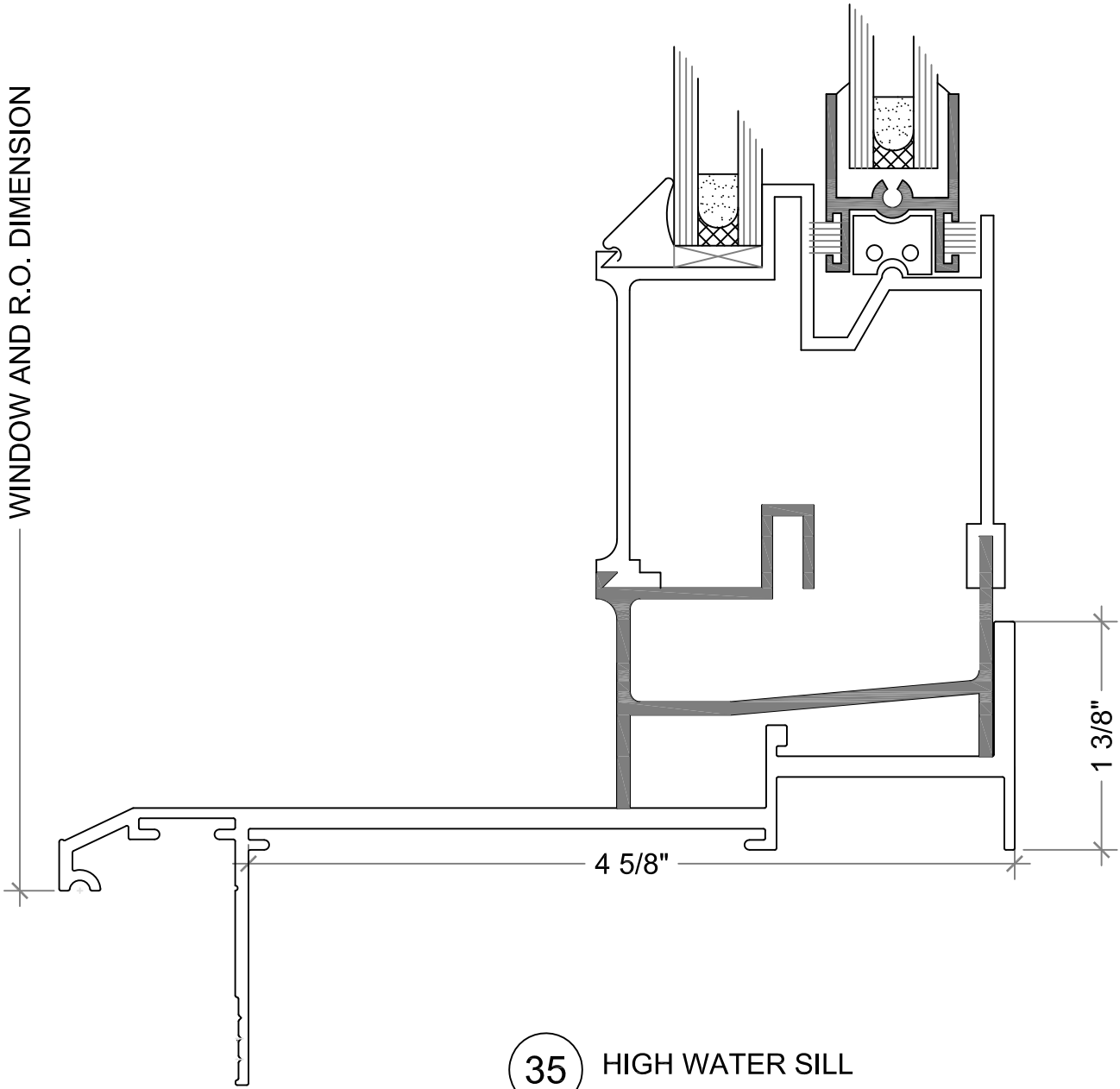

35 HIGH WATER SILL

500R SERIES RECESSED NAIL ON WINDOW

BONELLI
ENTERPRISES